

INTERNATIONAL AEROBATIC CLUB SCORESHEET

A	Contest:	Date:	Category: Advanced	Programme: Unknown	pilot's number	

No	Symbol	Catalogue No.	K	Total K	Grade	Remarks	Item	K	Score
1		1.1.7.1 9.1.1.1	9 6	15			Presentation	12	
2		2.3.4.4	34	34					
3		1.1.7.4 9.12.1.5	9 6	15					
4		5.2.1.1 9.4.1.2 9.9.5.3	17 9 11	37					
5		7.2.2.1 9.1.3.6 9.1.3.2 9.1.3.4 9.1.3.2	6 10 4 8 4	32					
6		7.3.3.3 9.9.4.4 9.4.4.2	14 11 5	30					
7		8.4.3.1 9.1.1.2 9.9.10.2	15 8 13	36					
8		8.6.4.1 9.1.3.2	14 4	18					
9		7.4.1.1 9.2.3.4	10 9	19					
10		8.4.1.1 9.1.1.3	13 10	23					
11		1.1.7.1 9.8.1.1	9 7	16					

FIGURE TOTAL K = 275

INCLUDING PRESENTATION = 287

Aircraft Type:

FREE PROGRAM CHECKED BY:

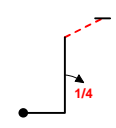
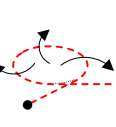
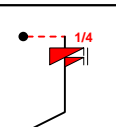
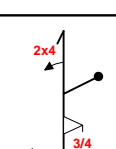
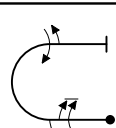
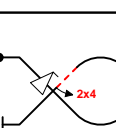
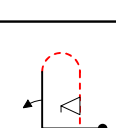
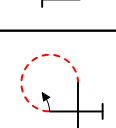
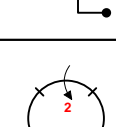
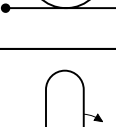
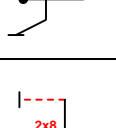
Signature:	Printed Name:	Date:

Judge
Name
Number



pilot



C	Contest:	Category: Advanced
Date:	Program: Unknown	Pilot's No. <input type="text"/>

wind direction

Pilot: _____

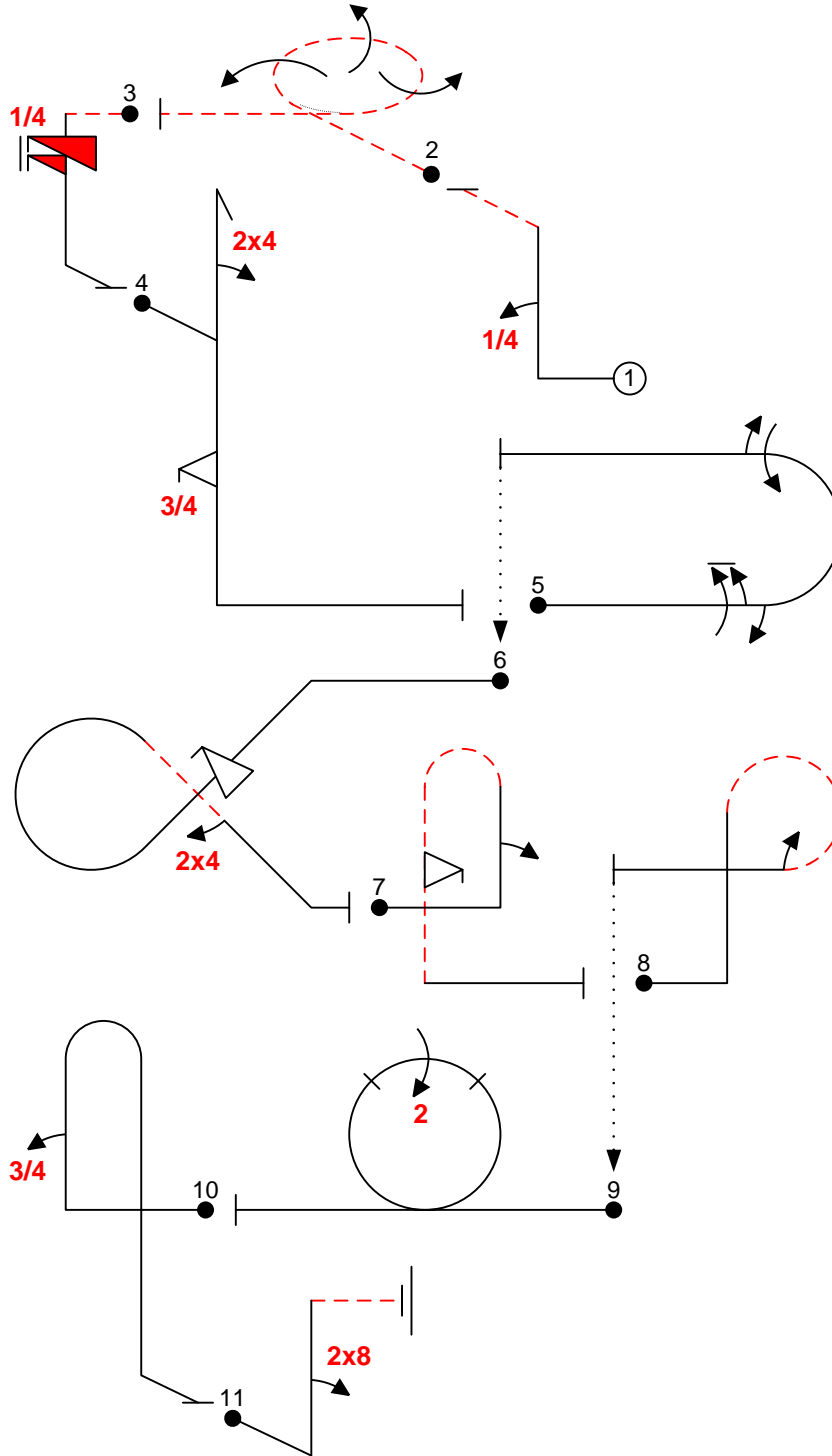

A/C: _____

(signature/date)

FREE PROGRAM CHECK BY: _____